

ORIGINAL RESEARCH ARTICLE

NB-IoT-based health monitoring system for COVID-19

Jiawen Chu¹, Yafei Wang^{1*}, Xuehua Li¹, Xiang Yun²

^{*1} School of Information and Telecommunication Engineering, Beijing Information Science and Technology University, Beijing 100192, China. E-mail: wangyafei@bistu.edu.cn

² Baicells Technologies, Beijing 100094, China

ABSTRACT

To address the problems of complex networking, low transmission rate and poor reliability of current health monitoring systems using Wi-Fi and Bluetooth transmission, an NB-IoT-based health monitoring system for COVID-19 is proposed. The system uses the STM32F103RET6 as the main controller, and the smart wearable device uses the NB-IoT information transmission method to transmit data to the software client platform with the OneNET cloud platform to realize the remote monitoring of key medical parameters of COVID-19. The test results show that the system is stable and reliable in data transmission, reducing the development cost and power consumption of existing health monitoring terminals, and has certain practical value and market prospects.

Keywords: COVID-19; NB-IoT (narrow band Internet of things); smart wearable devices; health monitoring; OneNET platform

1. Introduction

Health monitoring systems based on wearable smart devices help healthcare workers to prevent and diagnose diseases based on relevant medical data and take timely measures, which can effectively maintain people's health and life safety. With the advent of the 5G era and the continued maturity of the Internet of Things infrastructure, wearable smart devices are entering a new phase of development. Especially during the COVID-19 epidemic, the demand for monitoring key medical parameters such as body temperature and cough conditions as well as GPS positioning has increased significantly, and there is a new demand for the application of wear-

able devices.

At present, wearable smart medical devices are mainly used in the elderly and children's groups, and most of them use Wi-Fi or Bluetooth wireless transmission technology, such as fall detection systems for the elderly based on wearable sensors^[1], intelligent listening devices for paediatric diseases^[2] and so on. Due to the high pricing of the products, and the inability of Wi-Fi or Bluetooth wireless transmission technology to meet the business needs of large connection density, low power consumption and high compatibility^[3], these devices are difficult to be widely used.

Narrow band internet of things (NB-IoT),

ARTICLE INFO

Received: September 22, 2020 | Accepted: November 8, 2020 | Available online: November 25, 2020

CITATION

Chu J, Wang Y, Li X, et al. NB-IoT-based health monitoring system for Covid-19. *Wearable Technology* 2021; 2(1): 24–32.

COPYRIGHT

Copyright © 2021 by author(s). This is an Open Access article distributed under the terms of the Creative Commons Attribution License (<https://creativecommons.org/licenses/by/4.0/>), permitting distribution and reproduction in any medium, provided the original work is cited.

which is incorporated into the 5G technology standard, focuses on wide-area IoT scenarios, with the characteristics of large connectivity, wide coverage, low cost and low power consumption, and has the advantages of practicality, high reliability and cost-saving when applied to health monitoring systems^[4]. As a new space technology for narrowband wireless access, NB-IoT can coexist with existing cellular networks without the need for a new core network, which is conducive to reducing network deployment costs and accelerating deployment rates^[5]. Under NB-IoT, smart wearable devices can automatically access the server after successful registration, avoiding the complicated connection configuration operation of Wi-Fi, and greatly improving the networking rate of devices. At the same time, when the population base for epidemic monitoring is large, NB-IoT can effectively solve the problems of power consumption and connection density faced by smart wearable devices.

Therefore, to solve the problems of high cost and low reliability of traditional health monitoring systems, this paper proposes a design of a health monitoring system based on NB-IoT technology for COVID-19. The system integrates wearable sensor technology and NB-IoT communication technology and is designed and developed in the OneNET cloud platform using embedded software and hardware collaborative technology to achieve the monitoring of key medical parameters and remote control of warning lights in the web interface.

2. Demand analysis and overall system design

2.1. Demand analysis

Traditional health monitoring devices that use transmission methods such as Wi-Fi and Bluetooth have complex networking and low reliability, and most connected monitoring devices require independent development of backend servers by developers according to the actual application, increasing the development difficulty and extending the development cycle. In addition, although wearable devices with low latency sensitivity have low data transmission rate requirements, the access of a large number of devices and the processing of data place high demands on the connection density and energy consumption control of the system^[6]. According to the performance comparison of the commonly used wireless transmission technology in **Table 1**, NB-IoT technology has the characteristics of simple networking, high connection density, high reliability and low power consumption. It can effectively compensate for the shortcomings of the existing health monitoring system using Wi-Fi and Bluetooth technology in standby time, amount of accessible equipment and security, and can meet the market demand.

Table 1. Performance comparison of common wireless transmission technologies

Comparative content	Networking methods	Single network access node capacity	Transmission distance	Transmission speed /(Mibit.s ⁻¹)	Reliability	Battery life	Cost/\$	Network delay/s
Wi-Fi	Wireless router	Approx. 50	Short	11-54	Low	Few hours	25	<1
Bluetooth	Gateway for Bluetooth mesh	Theoretical approx. 60,000	Short	1	High	Few days	2-5	<1
NB-IoT	Existing cellular networks	Approx.100,000	Long	0.16-0.25	High	Theoretical approx. 10 years/AA batteries	2-3, with a future target of reducing to 1	6-10

The paper adopts NB-IoT data transmission technology for the design of the New Crown Pneumonia Health Monitoring System, making full use of the API interface and standard access proto-

cols provided by the OneNET platform to reduce the development difficulty and shorten the development cycle. The main functions of the system are:

(1) Data acquisition via sensors for cough, heart rate, blood pressure, body temperature, GPS, etc. (2) The collected sensor data are analyzed, and the working state of the warning lamp is controlled by the downlink command. The NB-IoT wireless communication technology is used to send the user’s health data to the OneNET cloud platform, and the data are displayed on the client to facilitate users to view. (3) Remote control and health monitoring of

warning lights based on the display of client information.

2.2. Overall system design

A COVID-19 health surveillance system was designed based on reference^[7]. It consists of four layers: data acquisition layer, communication layer, application service layer and user layer. The overall structure is shown in **Figure 1**.

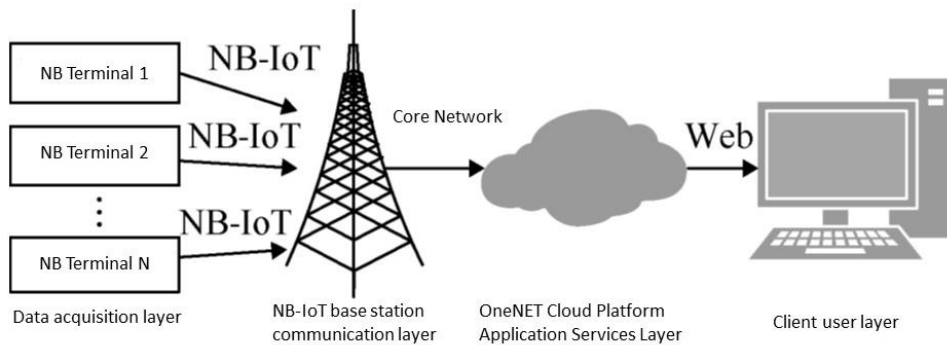

Figure 1. General architecture of the health monitoring system.

From left to right, layer 1 is the data collection layer, which mainly includes the NB terminal consisting of the main controller, health data monitoring module and GPS sensor, warning light, power supply module, NB-IoT communication module and so on. Among them, the health data monitoring module and GPS sensor store the collected data in the controller and send the parsed data to the mobile NB-IoT base station using the NB-IoT module. This layer is the underlying core part of the system.

Layer 2 is the communication layer. The data collected by the data acquisition layer is sent to the mobile NB-IoT base station through the NB IoT communication module, and then transmitted by the base station through the core network to the OneNET cloud platform. This layer is the core of the integration of the Internet of Things and narrowband communication technology.

Layer 3 is the application service layer, responsible for receiving data from NB-IoT base stations and configuring sensor resource parameters to upload the data to the OneNET cloud platform, which stores and analyses the data, eventually real-

izing the subscription of resources and remote control of terminal actuators.

Layer 4 is the user layer, which extracts and calls the data forwarded by the application service layer and forwards the downlink commands. Managers can remotely control and real-time monitor the health monitoring system through the Web operation interface.

3. System hardware design

The system hardware design mainly refers to the hardware design of the health monitoring terminal node, which is responsible for realizing the functions of the data collection layer. That is, the wearable monitoring equipment is used to realize the location report of the patients, the collection and processing of health information, and the collected data are uploaded to the NB-IOT base station to realize the communication connection of the communication module^[8]. The hardware structure is shown in **Figure 2**.

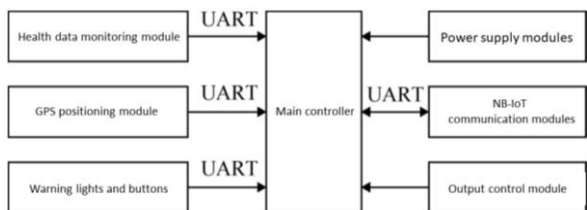

Figure 2. Terminal node hardware architecture design.

The main controller is the STM32F103RET6 microcontroller. The health-monitoring module consists of the ADXL345 3-axis acceleration sensor for determining falls and monitoring coughs, and the Yunkear MKB0908 smart wearer sensor for detecting the wearer’s heart rate, blood pressure and body surface temperature. The ADXL345 sensor detects the wearer’s spatial acceleration to determine their current state of motion. When the wearer reacts by falling or coughing, the sensor will report the monitored body fluctuation data. The main controller uses serial communication to receive data from the health monitoring module and GPS positioning module, sends data to the NB-IoT communication module via another UART, and then uses NB-IoT wireless communication technology to transmit the

received data to the IoT cloud platform. The working status of the warning light is determined by the value of the electrical signal output from the output control module^[9]. The power supply module uses an AC/DC switching power supply to output the 220 V AC input from the user to 5 V DC to power the various sensors, and the voltage is reduced to 3.3 V by DC/DC to power the main controller^[10].

The NB-IoT wireless communication module consists of the M5310-A NB module, SIM card holder, debug serial port, antenna, reset button, LED indicator and a power supply module to provide 5 V operating voltage. The M5310-A is a chip module in an LCC package measuring only 19 mm × 18 mm × 2.2 mm. It has built-in data transmission protocols such as UDP/CoAP and extended AT commands. The M5310-A module has a built-in data transfer protocol such as UDP/CoAP and extended AT commands, and uses a low power consumption technology with current consumption as low as 3 μA in PSM mode. The specific functions of the M5310-A module are shown in **Figure 3**.

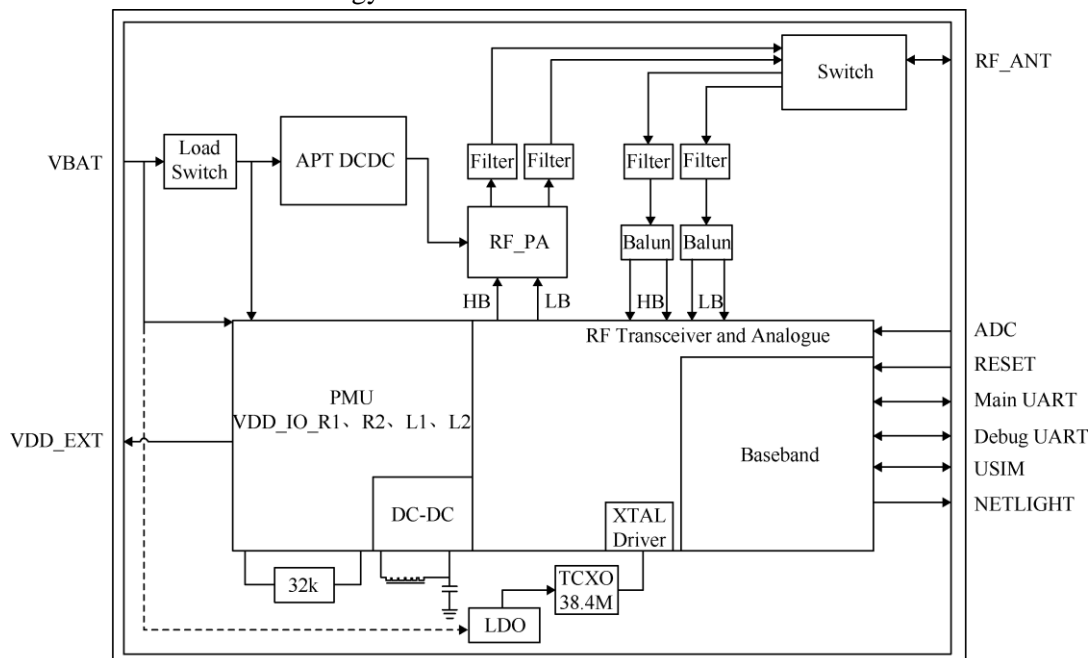

Figure 3. M5310-A module features.

The wireless communication module forwards the sensor data collected and processed by the main controller and the working status of the warning light to the IoT cloud platform via the Internet and receives commands from the user independently. The

design of the NB - IoT wireless communication module is shown in **Figure 4**.

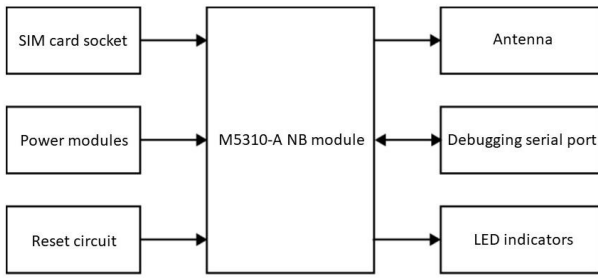

Figure 4. NB-IoT wireless communication modules.

4. System software design

The system software design mainly includes the design of the data communication protocol between the NB terminal and the IoT cloud platform. The communication protocol for accessing the NB base station in the communication layer of the overall system architecture, as well as the software design of the main controller of the NB terminal, the access process of the IoT cloud platform in the application service layer and the client software design in the user layer.

4.1. Data communication protocol design

The system is developed on the OneNET platform by adding corresponding NB-IoT devices and the communication between the NB terminal and the OneNET platform is realized by the LwM2M protocol and CoAP protocol based on NB-IoT^[11]. The CoAP protocol, which supports data retransmission and is suitable for low-power scenarios, is used for data transmission in the transport layer.

LwM2M as an application layer protocol defines logical operations such as read, write, execute, subscribe, etc. in the LwM2M Protocol for the identification of sensors and sensor attributes. CoAP is a network-oriented protocol based on the UDP protocol as a transport layer protocol, which is based on REST interactions and can be used to access IoT devices; CoAP abstracts resources according to the IPSO specification and follows the basic UDP protocol message format. Because of the transport unreliability of UDP as a non-connection-oriented protocol, CoAP has a retransmission mechanism and can detect regular redundancies in wireless sensor

network nodes, providing a better way to optimize resources.

In addition, as the NB terminal used in this system has a built-in SDK for interaction with the OneNET platform, a UDP connection can be established with a simple AT command. After the NB terminal has successfully acquired the Bootstrap server and returned the LwM2M access server address and port, the terminal device will automatically complete its access to the OneNET platform.

4.2. Terminal node software design

In the NB-IoT data transmission design used in this system, health data is sent from the main controller to the NB-IoT wireless communication module via UART, and then communicated with the mobile NB-IoT base station via CoAP, which is then forwarded to the OneNET cloud platform via the core network^[12].

The software design flow of the terminal is shown in **Figure 5**. Initialization operations are carried out automatically after the system is powered up. First is the initialization of the main controller microcontroller. Next is the initialization of the modules, including the NB-IoT communication module and the initialization of each sensor. Afterward, the sensor information is collected, parsed and stored by a timer, and the data is sent to the NB-IoT module, which is then uploaded to the IoT cloud platform.

4.3. IoT cloud platform

In the application service layer, the system uses China Mobile's OneNET IoT platform, a PaaS-level open cloud platform built by China Mobile for IoT technology, for storage and analysis of big data. The platform provides rich terminal access protocols and API interfaces^[13], which can effectively reduce the development difficulty of device access and connection, greatly shorten product development and deployment time, and provide a convenient and fast development and deployment solution for smart hardware, smart cities and other IoT scenarios. **Figure 6** shows the OneNET access flow.

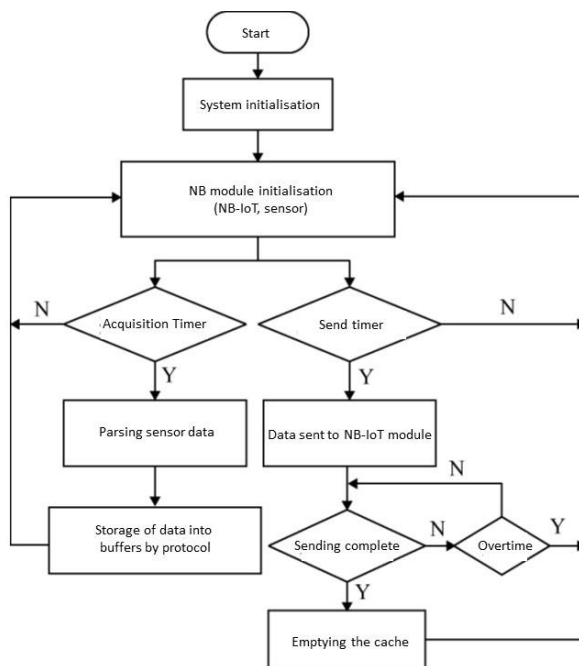

Figure 5. Terminal software design process.

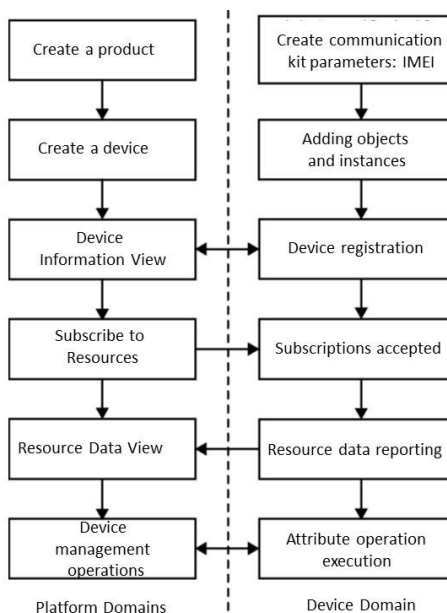

Figure 6. OneNET access process.

4.4. Client software design

The user layer uses a web interface. The client software platform is designed to enable the OneNET platform to interface with IoT devices, to obtain, parse and store data reported to the OneNET cloud platform from terminals through an API interface, and to display the data in the web application. For patients and healthcare professionals, this allows

them to have a dedicated operating platform without having to go through the OneNET platform to view data, enhancing the scalability of the system and the ease of operation for users. The flow of the client software platform operation is shown in **Figure 7**.

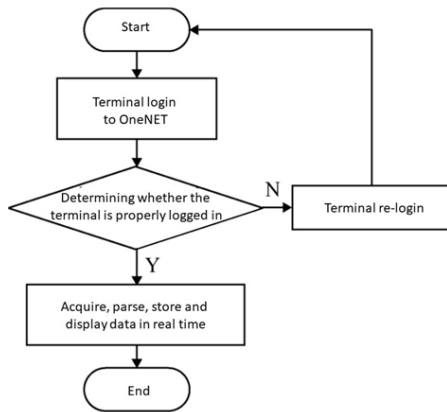

Figure 7. Client software design process.

5. System testing and analysis of results

To verify the effectiveness of the system, a wearable NB terminal was placed on the test subject to collect key medical data on COVID-19. After creating a device with the IMEI number of the NB terminal on the OneNET cloud platform, the data was uploaded to the cloud in 100 s intervals. It uses json technology, URL docking device API in OneNET platform and HTTP to push data to client Web interface for data analysis and remote monitoring.

5.1. Data upload and distribution testing

Data upload test

After creating the sensor-related resources and configuring the resource properties, the device carries the corresponding resource list to establish LwM2M communication and the server subscribes to all resources in the device resource list on its own. When the user periodically uploads the sensor value of a resource, the flag property of the resource needs to be set to NBIOT_UPDATED and the program will actively upload the sensor value of the subscribed resource to ONENet at the specified interval^[14]. As shown in **Figure 8**, the temperature and humidity sensor values are parsed in the main function and entered into the res_update function, which first sets the status of the temp resource to NBIOT_UPDATED and then receives the temperature and humidity sensor data periodically.

```

void res_update(time_t interval)
{
    double lon,lat;
    SHT20_INFO sht20;
    if(cur_time>=last_time+interval){
        cur_time=0;
        last_time=0;

        sbp.flag |= NBIOT_UPDATED;
        dbp.flag |= NBIOT_UPDATED;
        pul.flag |= NBIOT_UPDATED;
        human_temp.flag |= NBIOT_UPDATED;
    }
}
    
```

Figure 8. Key code for data upload to IoT cloud platform.

The test results show that the system is able to meet the functional requirements of the new crown pneumonia health monitoring, with low latency, high reliability and low power consumption for continuous operation using NB-IoT technology in the case of large amounts of medical data uploaded to the cloud. The data presentation of the health monitoring system sensor values on the OneNET platform is shown in **Figure 9**.

Object name	Number of examples	Number of attributes	Operation
Humidity	1	1	Details
Temperature	1	1	Details
Location	1	2	Details
Analog Input	7	7	Details
Illuminance	1	1	Details
Light Control	1	1	Details

Figure 9. Data presentation of health monitoring system sensor values on the OneNET platform.

Data distribution testing

The client sends downlink commands to the OneNET platform and the cloud platform forwards them to the NB terminal. The downlink commands are cached by the NB terminal so that the program can get the downlink control commands directly from the cache, and the write hook function in the resource corresponding to the command will be called automatically after the command is parsed at the device side to complete the operation related to the signalling. **Figure 10** shows the operating status

of the Boolean warning light.

```

Γεση_ζεε(αααα->Δεση_αα_ροοτ):
τλ(ορλτq==33τττετταατq==0εεεεαατq==2820)
   ιεατq'αααα->Δεση_αα_ροοτ ):
   τταετq'
   ορλτq'
βιτυεε( "μιττε \#q\#q\#q: #q/τ/υ"
      υρτοε_Δεση_ε_αααα )
      πτυετ_ε ιεατq'
      πτυετ_ε τταετq'
      Δοτq μιττε_αεττρεεκ( πτυετ_ε ορλτq'
  
```

Figure 10. Key code to control the warning light on and off.

The client’s web interface provides data retrieval and downstream control through the API interface provided by the platform, and stores the data in a MySQL database, ultimately realizing the control of the warning light’s working status and the display of health monitoring data. Figure 11 shows the web interface, which enables real-time monitoring of the wearer’s health and remote control of the warning light, saving manpower and material resources while improving the efficiency of healthcare workers.

5.2. Web interface presentation

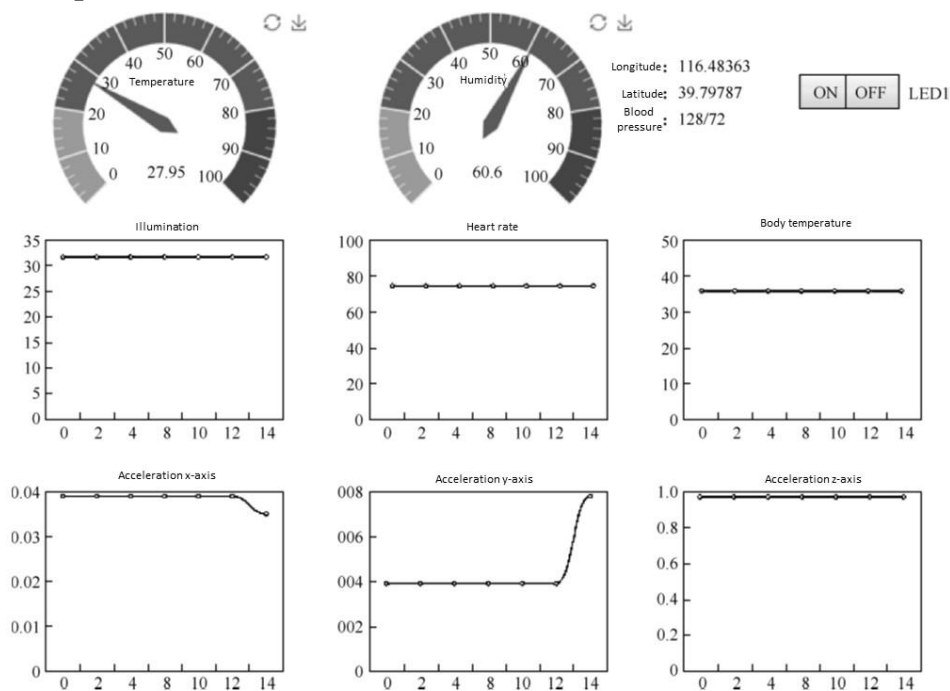

Figure 11. Web display interface.

6. Conclusions

This paper presents a NB-IoT-based health monitoring system for New Crown Pneumonia. The system is characterized by high reliability, low power consumption, high connection density and easy development. The test results show that the system is able to send the data collected by the sensors to the health monitoring platform using NB-IoT technology to achieve remote monitoring of the wearer’s relevant health parameters, as well as intelligent monitoring and control of the warning light. The system is not only geared towards the development needs of smart healthcare, but also has

a certain degree of universality compared to traditional solutions, and can be extended to smart meter reading, smart industry and other application scenarios, with good application value and market promotion prospects.

Conflict of interest

The authors declare no conflict of interest.

References

1. Gu Q. Research of fall detection technology based on wearable sensors [Master’s thesis]. Nanjing: Southeast University, 2015.
2. Chen Z. Research and implementation of wearable

- heart sound monitoring device [Master's thesis]. Chengdu: University of Electronic Science and Technology, 2019.
3. Cui J. Research apartment for the aged health monitoring system based on OneNet cloud platform [Master's Thesis]. Tangshan: North China University of Science and Technology, 2018.
 4. Shi Y. NB-IoT key technologies and application prospects. *Communication World* 2017; (17): 83.
 5. Dong Y, Nie Y. Research and design of NB-IoT-based smart parking system. *Journal of Nanchang Hangkong University (Natural Science)* 2017; 31(3): 95–99.
 6. Dai M. Research and design on wearable pre-warning system for remote health monitoring [Master's thesis]. Nanchang: Nanchang Hangkong University, 2015.
 7. Cheng K, Lian X, Zhou D, et al. Design of NB-IoT-based urban intelligent street light monitoring system. *Measurement and Control Technology* 2018; 37(7): 19–22.
 8. Yang F, Wang Y, Song H. Design of temperature and humidity control system based on narrowband IoT application architecture. *Application of Electronic Technique* 2018; 44(7): 59–63.
 9. Wang Y, Wu J, Wen J. *Embedded technology fundamentals and practice* (4th ed). Beijing: Tsinghua University Press, 2017, p.131–151.
 10. Zheng L. Intelligent monitoring system design of power supply based on Internet of Things. *Chinese Journal of Power Sources* 2017; 41(3): 493–494.
 11. Chen B, Chu Q, Sun Z, et al. An intelligent hardware networking method based on OneNet device cloud. *Journal of Harbin University of Science and Technology* 2017; 22(5): 76–80.
 12. Song H, Wang Y, Yang F. Design and implementation of intelligent street light control system based on narrowband Internet of Things. *Modern Electronic Technology* 2019; 42(2): 172–176.
 13. Yu Z, Yang G, Xie S. OneNET-based remote monitoring system for temperature and humidity of greenhouse. *Journal of Chinese Agricultural Mechanization* 2019; 40(2): 180–185.
 14. Yang P, Li S, Shi H. Design and implementation of an intelligent health housekeeper based on STM32 and OneNET. *Electronic Products World* 2019; 26(8): 60–64.