

Original Research Article

Mechanical Analysis of Secondary Lining of Super Shallow Buried Tunnel and Improvement of Construction Technology

DONG Guang

China Railway No.9 Group No.7 Engineering Co., Ltd., Shenyang 110000, China

Abstract: Based on the actual situation of the secondary lining of the Hongxing Tunnel in Dalian Bay, this article focuses on the mechanical properties of the secondary lining of the ultra -shallow buried tunnel underpassing the existing highway, mainly using the Taishaji theory and the Beijing mining method for the calculation of load and moment, shear force, axial force, etc. And the construction control measures of the second lining of the tunnel under the condition of super shallow buried and concealed excavation were put forward. Studies have shown that the mechanical analysis and calculation of the secondary lining used in this project are in line with reality, and the selection of the construction technology of the secondary lining is reasonable, and it is worthy of popularization and use in similar projects.

Keywords: Super shallow buried excavation; Mechanical analysis of the second lining; Construction ion technology of the second lining.

1. Project Background

Tunnel No. 1 and No. 2 of the Red Star are the main works of the 65053 Troop Exit Project in Dalian Bay. Among them, Red Star No. 1 tunnel (as shown in Figure 1) is 76m in length, the dark hole is 51m in length, and the distance from the top of the hole to the roadway is 4.6m; Red Star No. 2 tunnel is 91m in length, the dark hole is 63m in length, and the distance from the top of the hole to the roadway is 3.1m, and this paper analyzes the No. 2 tunnel as an object. The existing Zhenxing Road under Hongxing Tunnel is the main traffic channel from Dalian Development Zone to the city. During the construction period, no speed limit or measures affecting the passage shall be taken, and the settlement of the road surface shall not exceed 3cm during the construction period and the post-construction operation period. How to effectively control the settlement is the main technical difficulty of the construction project.

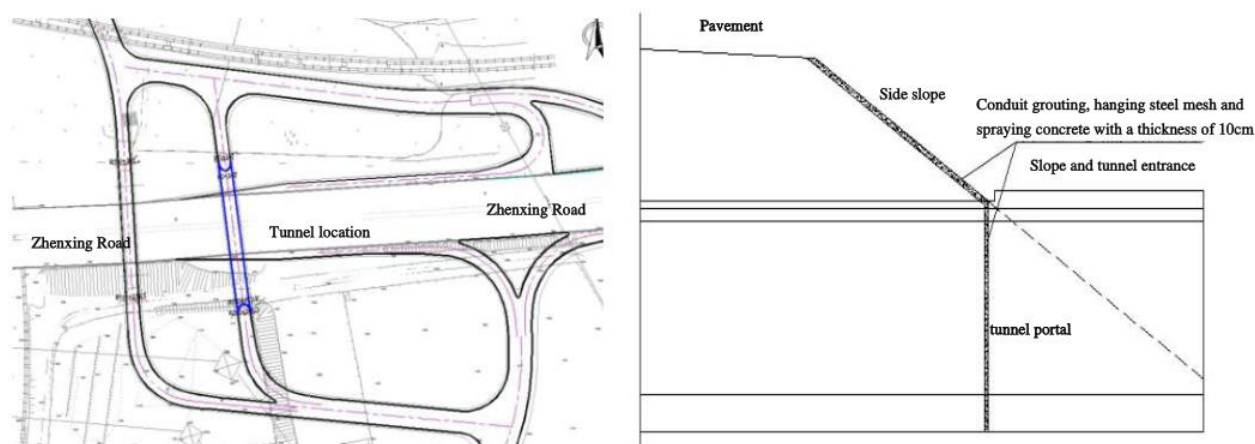

Figure 1 Plan and longitudinal section of Red Star Tunnel.

The landform of the Hongxing Tunnel site was originally an eroded remnant hill, which was later filled in as a road, with its elevation varying between 21.4~24.7m. The traversing soil layers are all roadbed plain fill, which is grayish black~brown in color. From top to bottom, 0~1.30m consists of clay and gravel and asphalt pavement, loose~dense, with 30~80% hard heterogeneous material content and 2~4cm particle size; below 1.30m, the content of gravel is increased to 70%, with 40% of the particle size 4~15cm and 30% of the particle size more than 80cm, which is a slightly dense state, with poor homogeneity and high compress ability. The thickness of layer is 2.40~7.50m, the depth of layer bottom is 2.40~7.50m, the elevation of layer bottom is 9.20~21.62m, and the backfill time is more than 10 years. The soil indexes are: $\gamma = 18.3kN / m^3$, $C = 18kPa$, $\phi = 15.0$, $\xi = 0.5$; $E_s = 3.30MPa$. Considering that a large number of heavy-duty vehicles pass through the revitalization road, the ground load refers to the relevant highway design specification, and the converted heap-loaded soil load is $25kN / m^2$.

2. Second Lining Force Theory and Construction Technology

According to the core definition of the new Austrian method of construction, to strengthen the self-sustaining force of the surrounding rock as the main means of tunnel construction, but the tunnel is buried in shallow depth, the upper vehicle load continues to act, the original surrounding rock for the roadbed filling soil, can not form a stable unloading arch structure, the self-sustaining force of the surrounding rock itself is close to nothing. Construction drawings taken in the CRD method and large pipe shed plus small conduit construction process to form the rigidity of the initial support system can not meet the settlement requirements, after a number of program demonstration, and ultimately decided to secondary lining in order to meet the safety reserve function under the premise of controllable rate of settlement to be the roof of the cave, that is, as a rigid body during construction, to control the amount of settlement of the roof of the cave.

Red Star Tunnel secondary lining in the construction process mainly experienced the following two stages: First, excavation, initial support to the completion of the second lining poured to reach a certain strength, the stage of the second lining of concrete has been finalized, but can not provide sufficient load-bearing control of the settlement of the vault, should be extremely avoided to avoid damage to the structure of the second lining force; second lining to meet the requirements of the bearing capacity of the whole process of the operating period to the stage of the second lining of the structure tends to be stabilized, and to be able to control the development of settlement of the vault to continue to meet the design requirements.

In order to avoid the first phase of the second lining force to produce adverse effects, the use of 4m short cart to speed up the second lining construction efficiency, and at the same time try to reduce the distance between the palm surface to the second lining, advance the timing of the second lining pouring, so that before the second lining construction of the settlement of the arch top is controlled within 2cm, the second lining pouring in the initial support and the second lining of the set between the 1cm-thick benzene plate, as a second lining to meet the requirements of the support force of the arch top settlement before the space reserved. At the same time, the concrete grade was raised to C50, and an early-strengthening agent was added to make the second lining quickly reach the requirement of support force. Calculation of the effective support force of the second lining under the special working conditions of this tunnel and the concrete grade and reinforcement rate that the second lining should be subjected to are the key data for the construction of the second lining.

3. Mechanical Analysis of the Second Lining

The mechanical behavior of the second lining of the Hongxing Tunnel is analyzed by the traditional Taisha base theory and the Beijing Kuangshan method without considering the favorable effect of the initial support, respectively.

3.1 Design Material

The calculation diagram is shown in Figure 2.

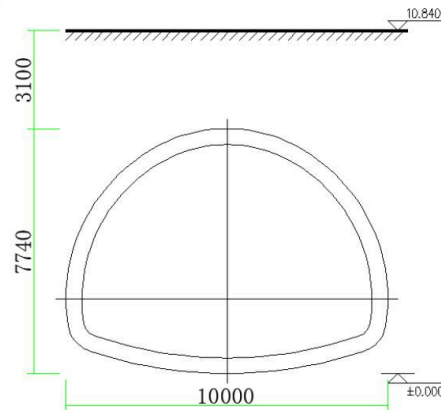

Figure 2 Cross section of Red Star tunnel.

3.2 The Results of the Calculations Using the Tyshaki Theory are as follows:

Axial force: positive for tension, negative for compression; bending moment: positive for inner tension, negative for outer tension.

3.2.1 Load Standard Value Calculation

3.2.1.1 The Structural Self-Weight (unilateral) is shown in Table 1

Table 1 Structural deadweight table.

Position	Wall thickness(mm)	Length(mm)	Dead load(kN)
Top vault	500	2.225	27.816
Upper side vault	500	5.498	68.722
Middle side vault	500	0.829	10.358
Below side vault	500	0.809	10.107
Bottom vault	500	4.270	53.374

3.2.1.2 Ground Soil Pressure

Calculation of vertical uniform pressure:

Depth of overburden: $h = 3.100m \leq D = 10.00mm$ shallow buried.

Vertical soil pressure:

$$q_v = \gamma h_i = 18.300 \times 3.100 = 57.730 kN / m^2$$

Top of lateral pressure:

$$\begin{aligned} q_{ht} &= \left(\gamma h + r_1 \frac{T}{2} \right) k_h \\ &= \left(18.300 \times 3.100 + 18.300 \times \frac{0.500}{2} \right) \times 1.000 = 61.305 kN / m^2 \end{aligned}$$

Bottom of lateral pressure:

$$\begin{aligned} q_{h2} &= \left(\gamma h + r_1 \left(\frac{T}{2} + H_t \right) \right) k_h \\ &= \left(18.300 \times 3.100 + 18.300 \times \left(\frac{0.500}{2} + 7.240 \right) \right) \times 1.000 = 193.797 kN / m^2 \end{aligned}$$

3.2.1.3 Surface Stowage

The load value is: $q_{Dv} = 25kN / m^2$

The load creates lateral pressure:

$$q_{Dh} = q_{Dv}k_h = q_{Dv}k_h = 25.000 \times 1.000 = 25.000kN / m^2$$

3.2.1.4 Earthquake Access

① Dead weight horizontal inertia force

Inertia force calculation formula:

$$F_{ihE} = \eta A_g m_i$$

$$\eta = 0.20, A_g = 0.10g$$

The results of the calculation of the horizontal inertia force of the self-weight of each part are shown in Table 2.

Table 2 Summary of horizontal inertia force by self-weight of each part.

Position	Mass (kg)	F_{ihE} (kN)	H (m)	F_{ihE} (Kn/m)
Top vault	2.836	0.556	0.569	0.977
Upper side vault	7.005	1.374	4.547	0.302
Middle side vault	1.056	0.207	0.825	0.251
Below side vault	1.030	0.202	0.590	0.342
Bottom vault	5.441	1.067	0.708	1.507

② Horizontal inertia force of the soil column on the roof of the cave:

$$F = \eta A_g m = F = 0.200 \times 0.100 \times 18.300 \times 10.000 \times 3.100 = 11.346kN$$

③ Earth pressure increment:

$$K_a = \left(\tan \left(45^\circ - \frac{\varphi}{2} \right) \right)^2 = \left(\tan \left(45^\circ - \frac{15.000}{2} \right) \right)^2 = 0.58879$$

$$k'_a = \left(\tan \left(45^\circ - \frac{\varphi - \theta}{2} \right) \right)^2 = \left(\tan \left(45^\circ - \frac{15.000 - 3.000}{2} \right) \right)^2 = 0.65575$$

Lateral pressure top:

$$\begin{aligned} q_{h1} &= \left(\gamma h + r_1 \frac{T}{2} \right) (K_a - K'_a) \\ &= \left(18.300 \times 3.100 + 18.300 \times \frac{0.500}{2} \right) \times (0.58879 - 0.65575) \\ &= 4.102kN / m^2 \end{aligned}$$

Lateral pressure bottom:

$$\begin{aligned} q_{h2} &= \left(\gamma h + r_1 \left(\frac{T}{2} + H_t \right) \right) (K_a - K'_a) \\ &= (18.300 \times 3.100 + 18.300 \times (0.500 + 7.240)) \times (0.58879 - 0.65575) \\ &= 12.886kN / m^2 \end{aligned}$$

3.2.1.5 The Force Diagram for Each Working Condition is shown in Figure 3.

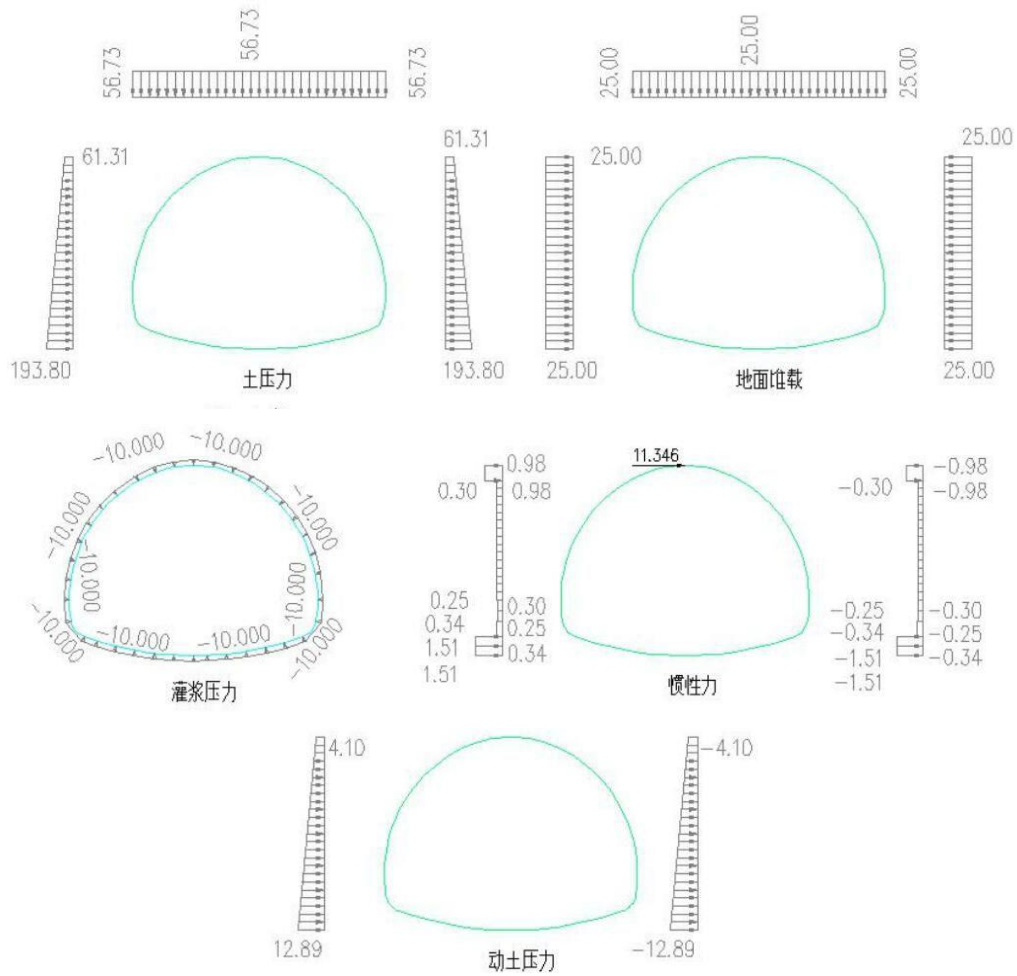

Figure 3 Sketch of the calculated forces for each working condition using the Taishaji theory.

3.2.2 Load Standard Value Calculation

Calculation of the internal force of the second lining using the Taishaji theory is shown in Figure 4 for each part of the tunnel member numbering. The force analysis of the second lining members is shown in Figure 5.

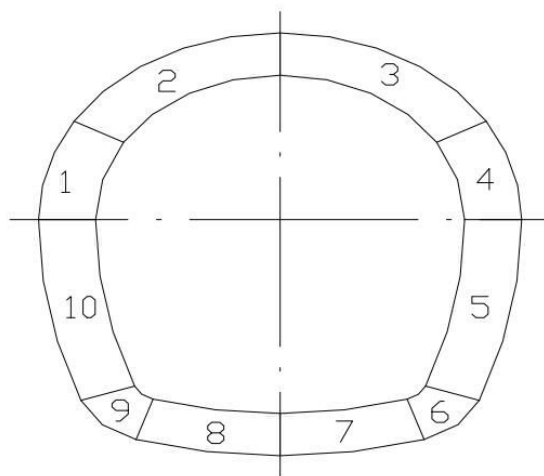

Figure 4 Component numbering diagram.

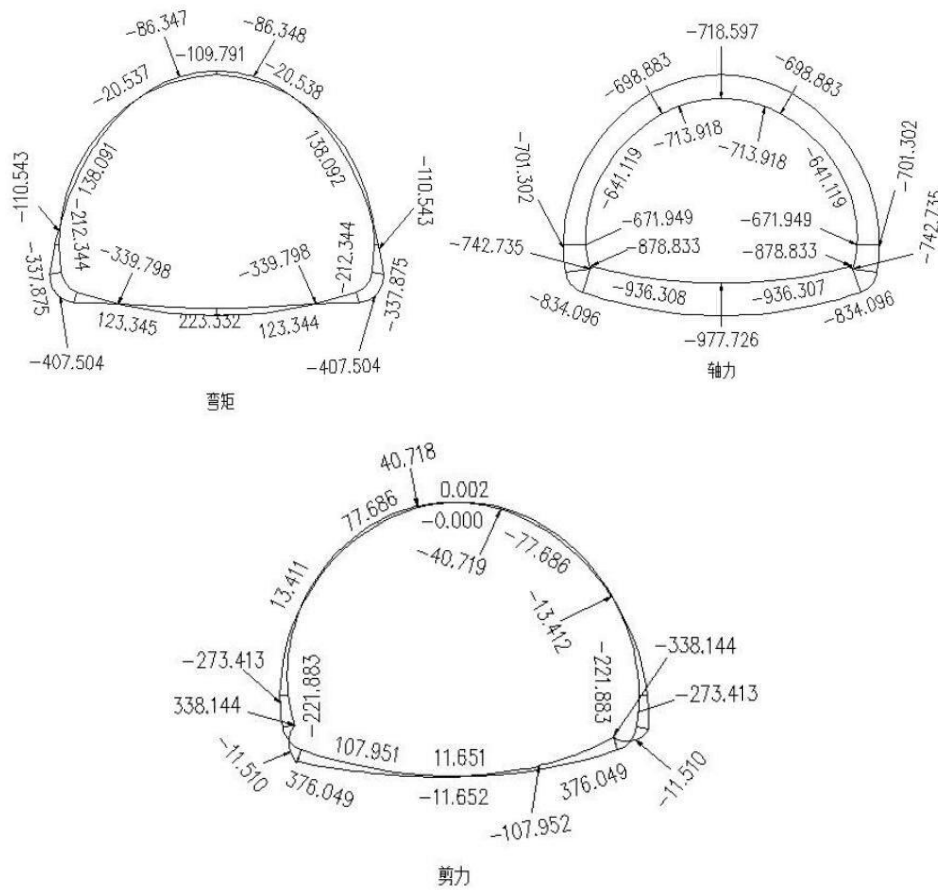

Figure 5 Analysis of the two-lining stress structure calculated by Taishaji theory.

3.3 The results of calculations using the Beijing Kuangshan method are as follows:

Axial force: tension is positive, compression is negative; bending moment: inner tension is positive, outer tension is negative.

3.3.1 Calculation of Load Standard Value

3.3.1.1 Structural deadweight (unilateral)

Cite the parameters in Table 1: Structural deadweight table.

3.3.1.2 Ground Soil Pressure

① Calculation of vertical uniform pressure:

$$a_1 = \frac{D}{2} + H_t \tan\left(45^\circ - \frac{\varphi}{2}\right) = \frac{11.620}{2} + 7.740 \times \tan\left(45^\circ - \frac{15.00}{2}\right) = 11.749 \text{ kN} / \text{m}^2$$

$$K_1 = \frac{\tan(\varphi) \left(\tan\left(45^\circ - \frac{\varphi}{2}\right)\right)^2}{2a_1} = \frac{\tan(15.00) \times \left(\tan\left(45^\circ - \frac{15.00}{2}\right)\right)^2}{2 \times 11.749} = 0.00671$$

$$K_2 = \frac{c \left[1 - 2 \tan(\varphi) \tan\left(45^\circ - \frac{\varphi}{2}\right) \right]}{a_{1\gamma}}$$

$$= \frac{18.000 \times \left[1 - 2 \times \tan(15.00) \times \tan\left(45^\circ - \frac{15.00}{2}\right) \right]}{11.749 \times 18.30} = 0.04929$$

$$K_3 = \frac{K_1 D + K_2}{1 - K_1 D - K_2}$$

$$D = \frac{0.007 \times 11.620 + 0.049}{1 - 0.007 \times 11.620 - 0.049} \times 11.620 = 1.69513$$

$$D_1 = \frac{1 - K_2 - K_1 K_3 D + K_2}{2K_1} = \frac{1 - 0.04929 - 0.00671 \times 1.69513}{2 \times 0.00671} = 69.95333m$$

$$h = 3.100m \leq D = 11.620m \quad \text{shallow-buried}$$

$$\sigma_v = \gamma h = 18.300 \times 3.100 = 56.730kN / m^2$$

② Calculation of lateral uniform pressure:

$$\sigma_h = (\sigma_v + 0.5\gamma H_t) \left(\tan\left(45^\circ - \frac{\varphi}{2}\right) \right)^2$$

$$= (56.730 + 0.5 \times 18.300 \times 7.740) \times \left(\tan\left(45^\circ - \frac{15.00}{2}\right) \right)^2$$

$$= 75.101kN / m^2$$

3.3.1.3 Surface Stowage

The load value is: $qD_v = 25.00kN / m^2$

The load creates lateral pressure:

$$qD_h = qD_v k_h = qD_v \left(\tan\left(45^\circ - \frac{\varphi}{2}\right) \right)^2$$

$$= 25.000 \times \left(\tan\left(45^\circ - \frac{15.00}{2}\right) \right)^2 = 14.720kN / m^2$$

3.3.1.4 Earthquake Access

The data results are the same as those of 3.2.1.4 earthquake access, and no repeated calculations are required.

3.3.1.5 The schematic diagram of force in each working condition is shown in Figure 6

3.3.2 Figure 4 shows the schematic diagram of component numbers for calculating secondary lining internal forces using Beijing Kuangshan method

The schematic diagram of component numbering is shown in Figure 4.

The force analysis of the secondary lining member is shown in Figure 7.

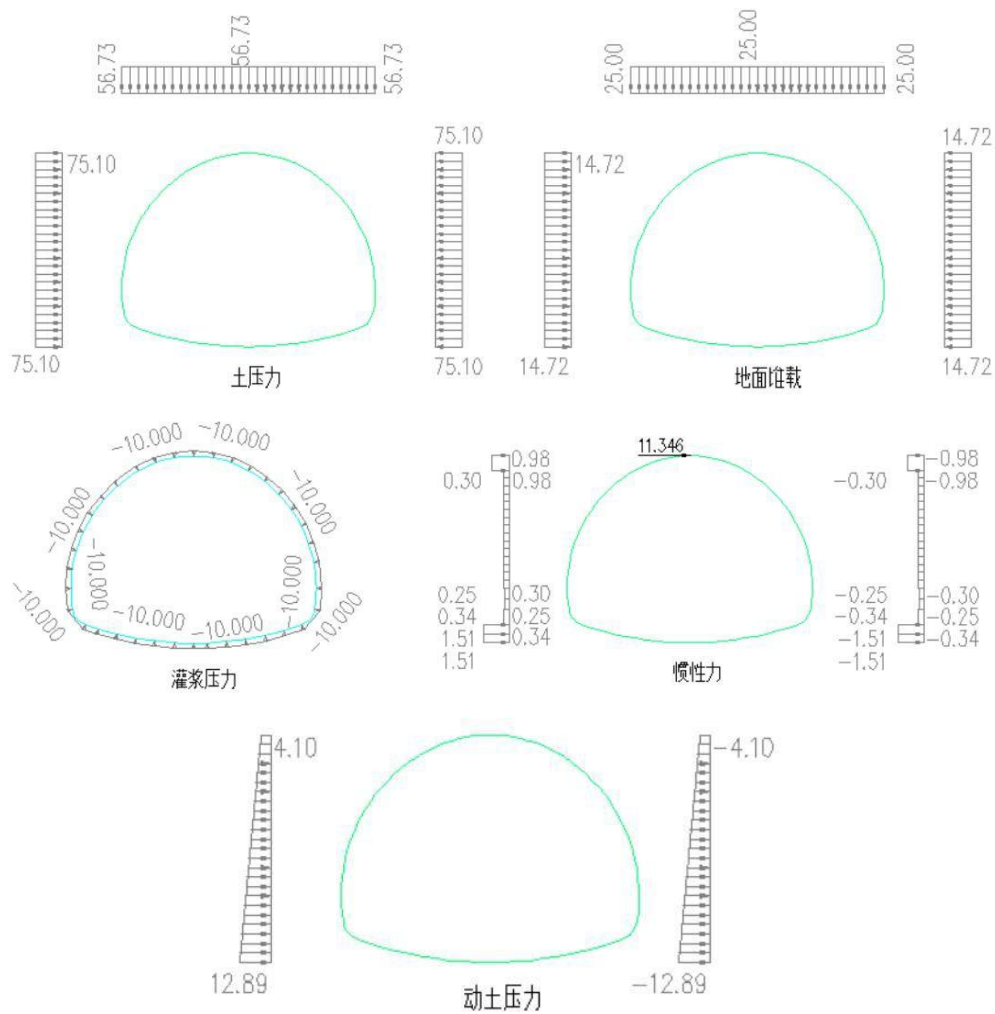

Figure 6 The stress diagram of each working condition was calculated by using Beijing Kuangshan method.

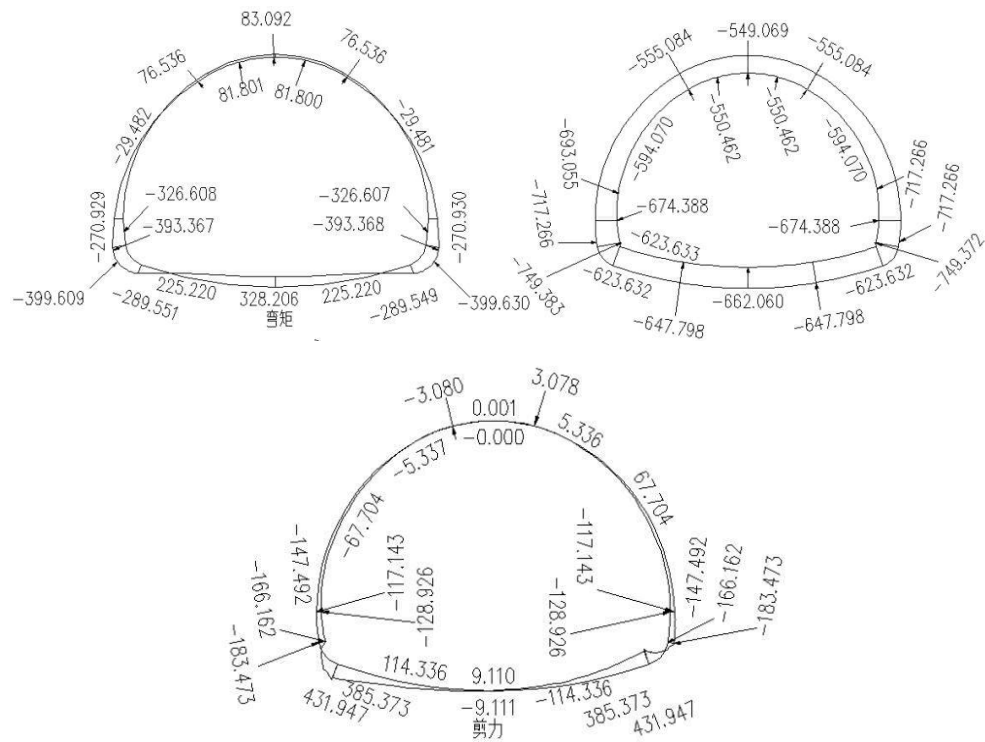

Figure 7 Analysis of secondary lining mechanical structure calculated by using Beijing Kuangshan method.

Table 4 The selection of steel bars and cracks calculated by Beijing Kuangshan method.

Components	Position	Combination	AS (mm ²)	The selection of steel bars	Combination	M (kN*m)	N (kN)	Rift (mm)
3	Outside	1	750	D10@200	---	---	---	---
	Inside	1	750	D10@200	1	46.341	-377.171	0.000
4	Outside	1	2043	D10@120	1	-176.104	-450.315	0.051
	Inside	1	1021	D10@150	1	46.341	-377.171	0.000
5	Outside	1	2982	D10@50	1	-263.590	-482.640	0.090
	Inside	1	1491	D10@100	---	---	---	---
6	Outside	1	3167	D10@80	1	-276.660	-511.613	0.113
	Inside	1	1491	D10@100	---	---	---	---
7	Outside	1	2185	D10@70	1	-198.274	-429.686	0.063
	Inside	1	2481	D10@60	1	216.013	-462.834	0.051

5. Conclusions and Recommendations

This paper according to the Dalian Bay 65053 Tank Force export project of ultra-shallow buried tunnels construction specific circumstances, through the analysis of the mechanical behavior of the second lining, the use of short cart, high grade concrete and in the second lining and the initial support of the addition of settlement between the inter-layer and other measures to reasonably improve the construction process, improve some of the parameters of the material performance, and successfully solved the problem of similar tunnels difficult to control the settlement of the ground, the Red Star Tunnel after many years of operation is still in good condition, the theoretical method of the settlement control of the construction of tunnels is worthwhile to be popularized in the use of similar engineering projects.

References

1. GB 50010-2010, Code for design of concrete structures [S].
2. GB 50009-2012, Code for structural loading of buildings [S].
3. GB 50011-2010, Code for Seismic Design of Buildings [S].
4. GB 50157-2013, Subway Design Code [S].
5. JTG D70-2-2014, Design specification for highway tunnels [S].